

LANDSCAPE

design Joost van der Vecht 2012

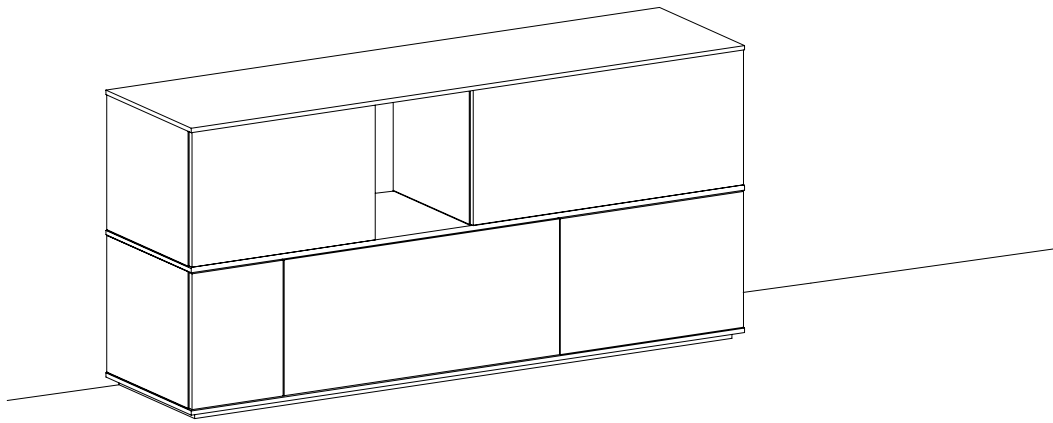

LANDSCAPE - on a plinth

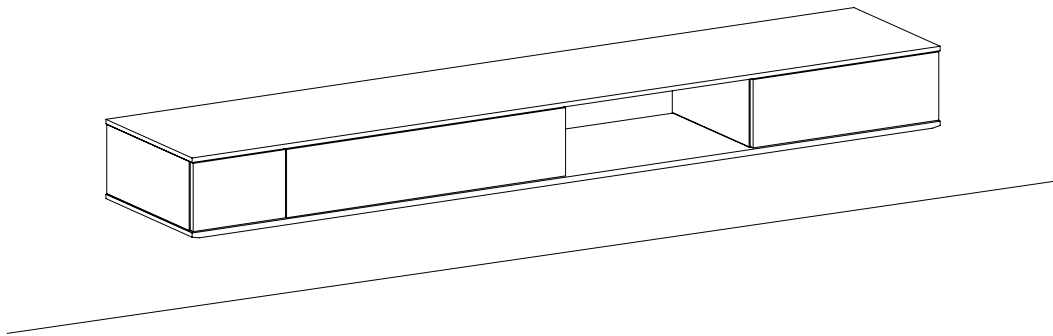

LANDSCAPE - wall mounted

pastoe

pastoe
sleepboot 4
3991 cn houten
the netherlands

info@pastoe.com
www.pastoe.com

LANDSCAPE

design Joost van der Vecht 2012

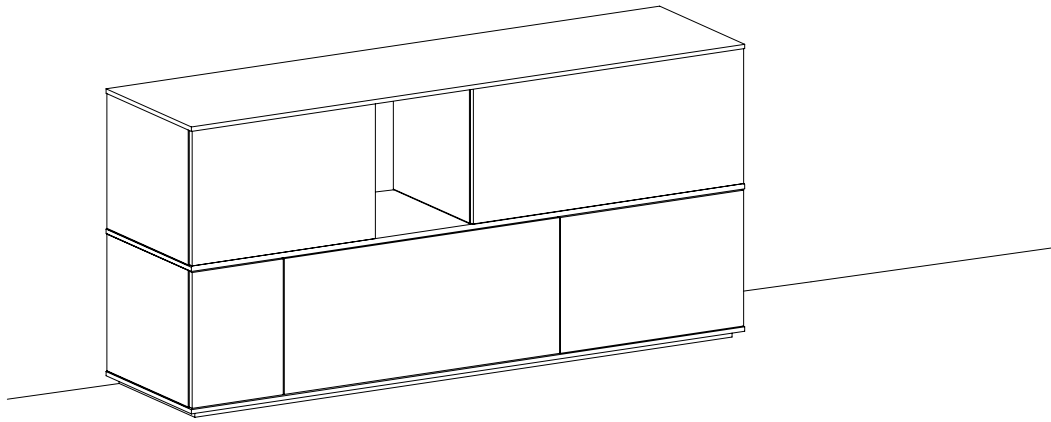

LANDSCAPE - on a plinth

Components

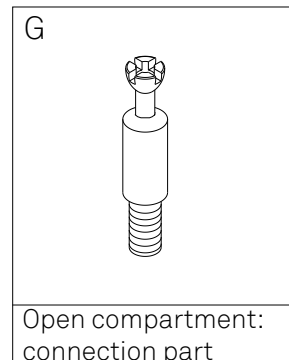
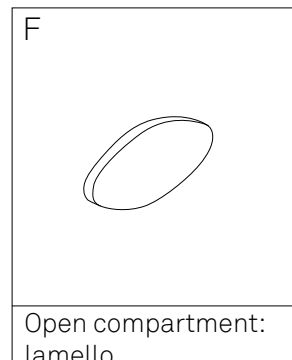
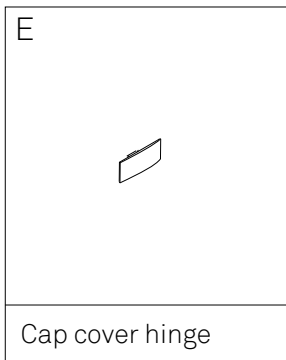
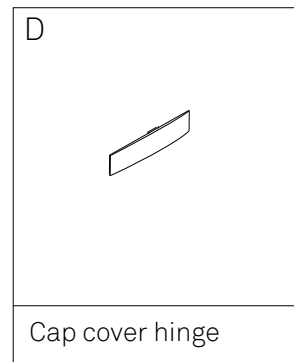
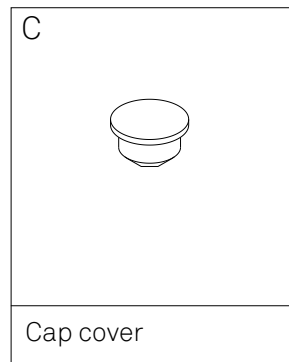
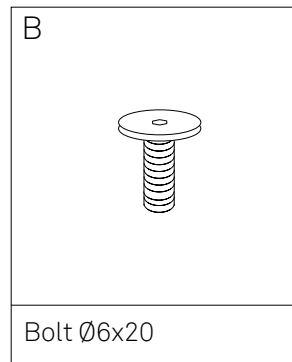
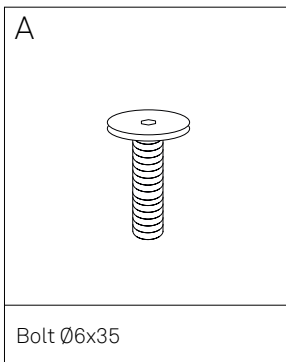

Assembly instructions

1

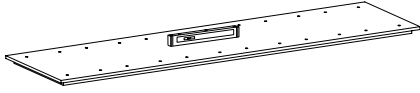

Place the plinth at the desired position and adjust until level using the adjustable legs.

2

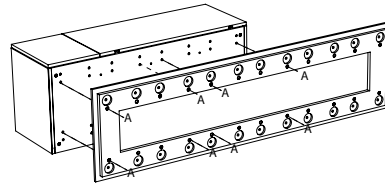

Rotate the plinth so that the underside can be accessed and place the body. Screw the body to the underside of the plinth using the supplied bolts (A; L=35mm).

3

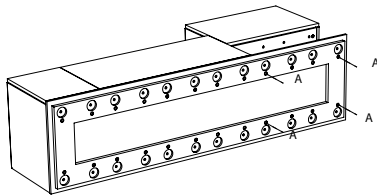

Place the second body in the same manner.

4

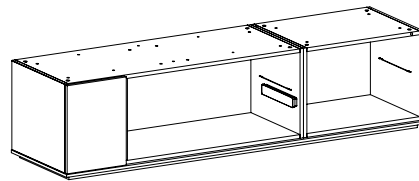

Set the cabinet in the desired position.

5

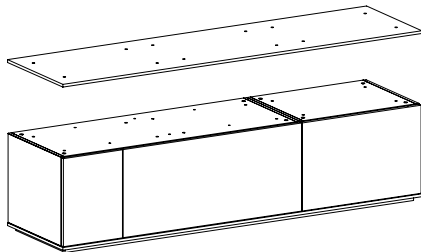

Place the divider.

6

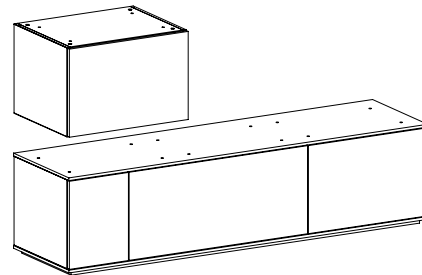

Place the body on the divider.

7

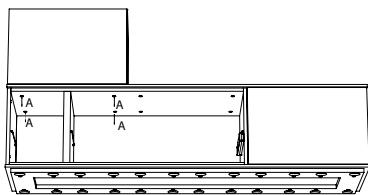

Secure the body from the cabinet underneath using the supplied long bolts (A; L=35mm).

8 OPEN COMPARTMENT

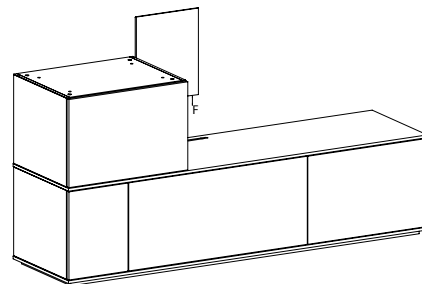

If this cabinet does not feature an open compartment, please go on to step 11.
Place the back panel using the lamellos (F).

Assembly instructions

9 OPEN COMPARTMENT

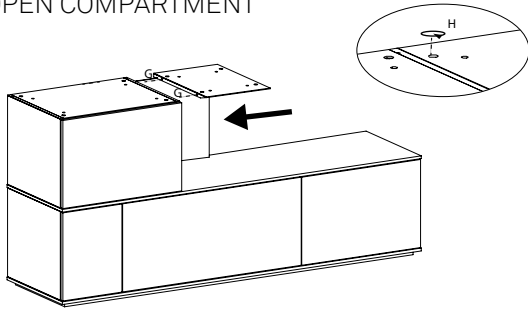

screw the eccentric bolt into the side of the body and slide the open compartment construction plank into position. Secure this by tightening the minifix (H).

10 OPEN COMPARTMENT

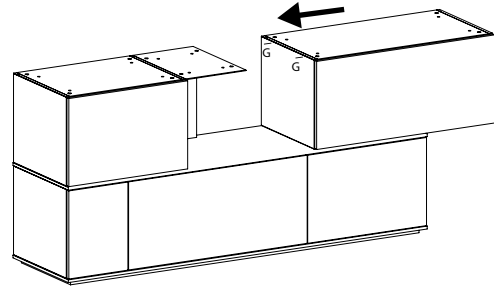

Place the next body on the divider. Place the eccentric bolts (G) in the side and slide it against the construction plank. Secure by tightening the minifix (H).

11

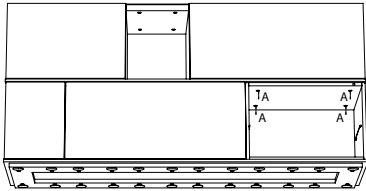

Secure the body from the body underneath using the long bolts (A=35mm).

12

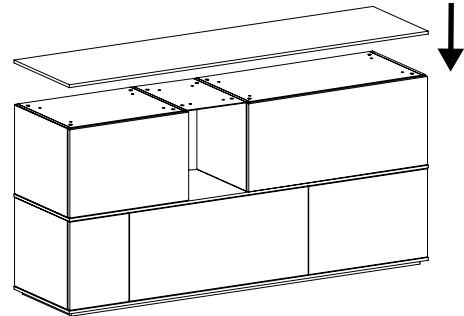

Place the top.

13

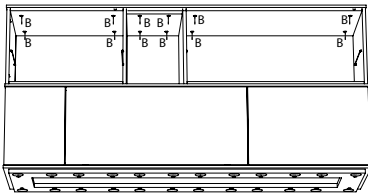

Secure the top from the bodies underneath using the supplied short bolts (B=20mm). NOTE! Be sure to use the short bolts for this. The long bolts could damage the top.

14

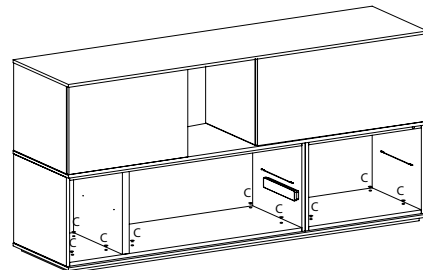

Adjust the fronts and, if needed, adjust the cabinet again using the adjustable feet attached to the bottom bodies. Place the cover caps (C).

15

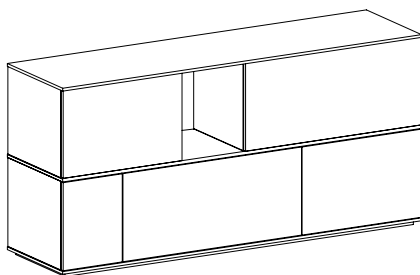



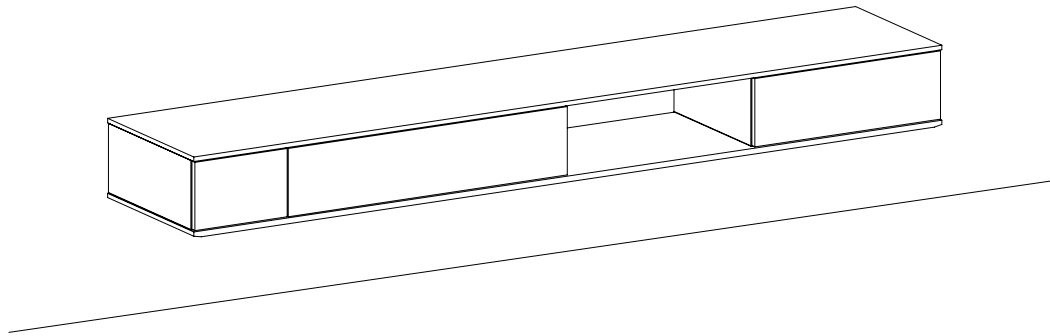

LANDSCAPE

design Joost van der Vecht 2012

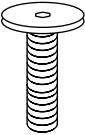
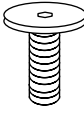

LANDSCAPE - wall mounted

Components

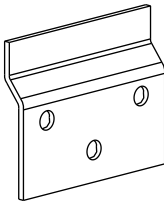
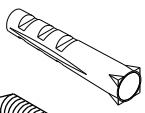
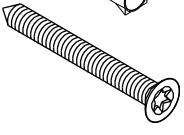
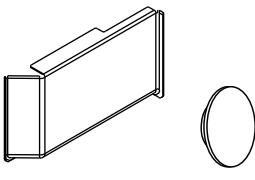
<p>A</p> 	<p>B</p> 	<p>C/D</p> 	<p>E</p> 
<p>Bolt $\text{\O}6 \times 35$</p>	<p>Bolt $\text{\O}6 \times 20$</p>	<p>Cap cover hinge</p>	<p>Open compartment: lamello</p>
<p>F</p> 	<p>G</p> 	<p>H</p>  <p>I</p> 	<p>J/K</p> 
<p>Open compartment: connection part</p>	<p>Mounting plate</p>	<p>Plug and screw $\text{\O}5 \times 45$</p>	<p>Cover mounting part</p>

Assembly instructions

NOTE: The cabinet must be assembled so it can be mounted on the wall. The cabinet is to be mounted on the wall as a whole. To do so, please follow the steps below.

To mount cabinets starting at 2.85m on the wall, three people will be required.

1

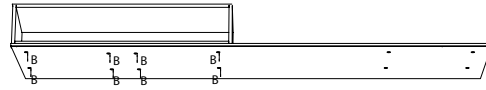
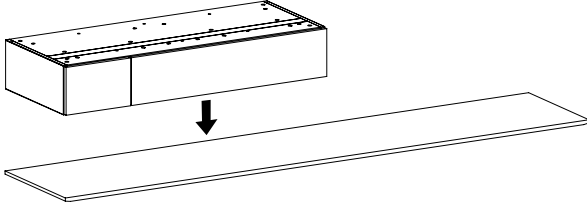

Secure the base from the bottom using the supplied bolts (B; L=20mm).

2 OPEN COMPARTMENT

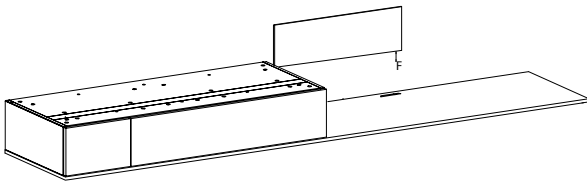

If this cabinet does not feature an open compartment, please go on to step 5.
Place the back panel using the lamellos(E).

3 OPEN COMPARTMENT

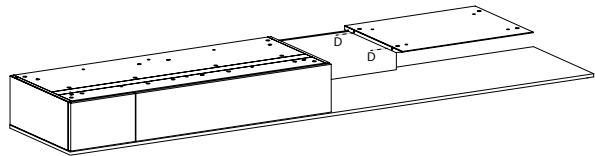
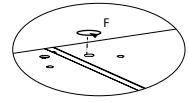

Place the open compartment over the back panel by sliding it over the connecting bolt.

4 OPEN COMPARTMENT

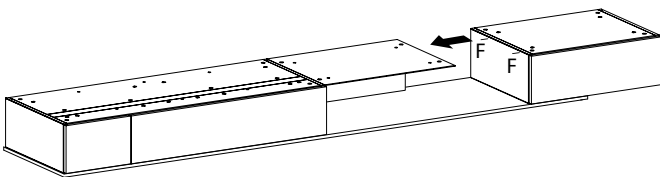
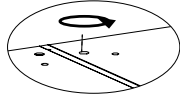

Place the following body. Tighten the minifixes.

5

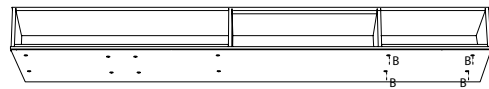

Secure the base from the bottom using the supplied bolts (B; L=20mm).

6

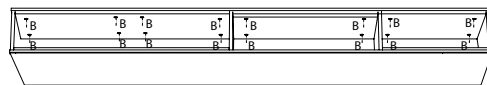
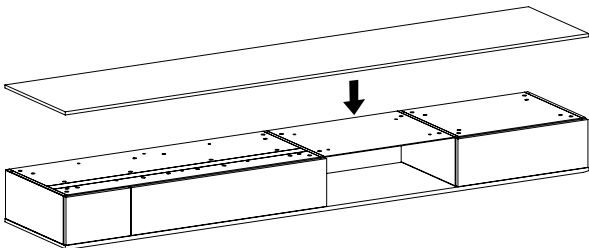

Secure the finishing top from the bodies underneath using the supplied short bolts (B; L=20mm).
NOTE! Be sure to use the short bolts for this. The long bolts could damage the top.

Assembly instructions

7

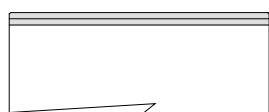
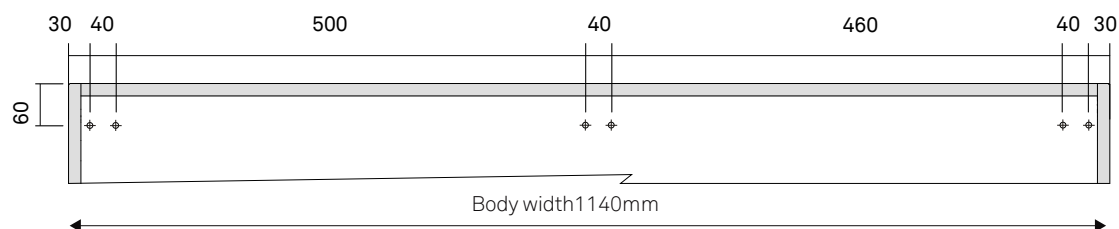
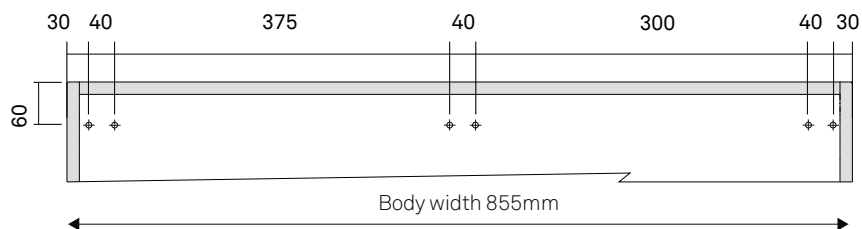
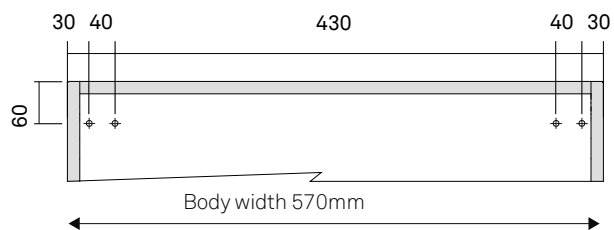
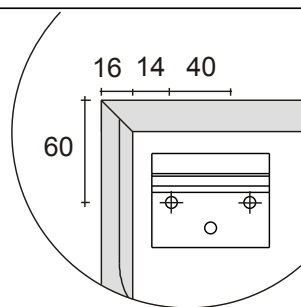
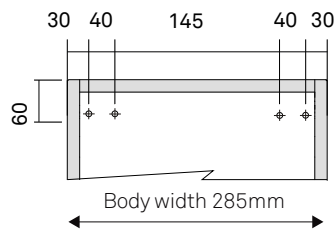

Open compartment width 285mm

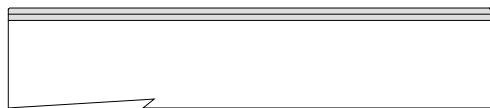

Open compartment width 570mm

Holes to be drilled in the facing side:

Drill the required holes in the wall according to the width of the body. Open compartments do not require (or have) hangers. Do take the width into account when measuring out where to drill the holes.

Assembly instructions

